

## LED ultra-thin street lamp

Professional LED  
Supplier



PC lens  
ultra-thin and durable  
guaranteed for three years

AX-LD-FD2  
AC85-305V  
100W/150W/200W/250W

AX-LD-FD2-200W

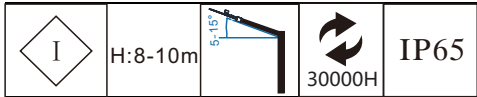

## FIXED ROAD LAMP SERIES



### Features & Application

- ◆ Adopt high-stability isolated constant current power supply scheme, it has the characteristics of over-temperature protection, wide voltage range, high power factor, high efficiency and good heat dissipation effect.
- ◆ SMD2835 patch light source is adopted
- ◆ Adopt high purity aluminum radiator with high thermal conductivity to maintain reasonable temperature.
- ◆ Stadium, stadium, workshop, warehouse and other

### Product specifications

Input voltage	AC 100-305V ~ 50/60Hz	Size of Standard version model	676mm*255mm*83mm
Power	200W±5%	Size of light-induced version model	676mm*255mm* 123mm
Light effect	100-140lm/W	Net weight	2.84kg
Luminous flux	20000-28000lm	THD	≤15%
light emitting diode	300pcs*SMD2835/3030;	Insulation grade	Class I
Color temperature	6000k/4000k/3000k	Surge protection	4KV
Color rendering index	Ra > 70	Installs Way	Lamp post
Color tolerance adjustment	≤15SDCM		
Power factor(K/Z)	PF≥0.9		
IK/IP protection level	IK08/IP65		
Working temperature	-25°C— +40°C		
Service life	30000 H		

# Product size



## Product size

Standard version model: 676mm\*255mm\* 83 mm.

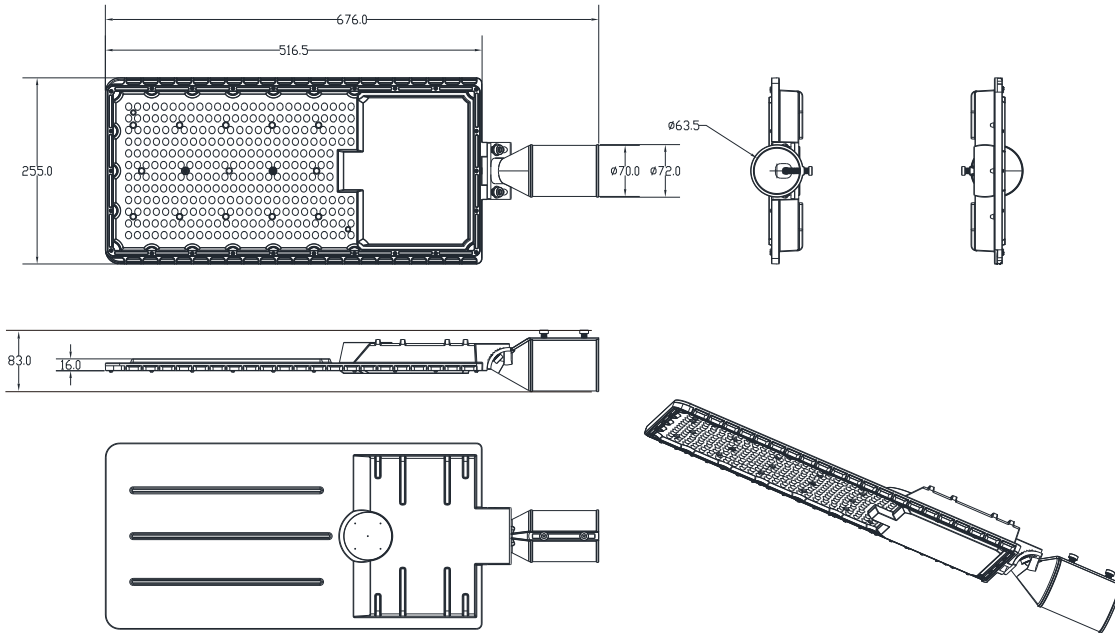

Light-induced version model: 676mm\*255mm\* 123mm

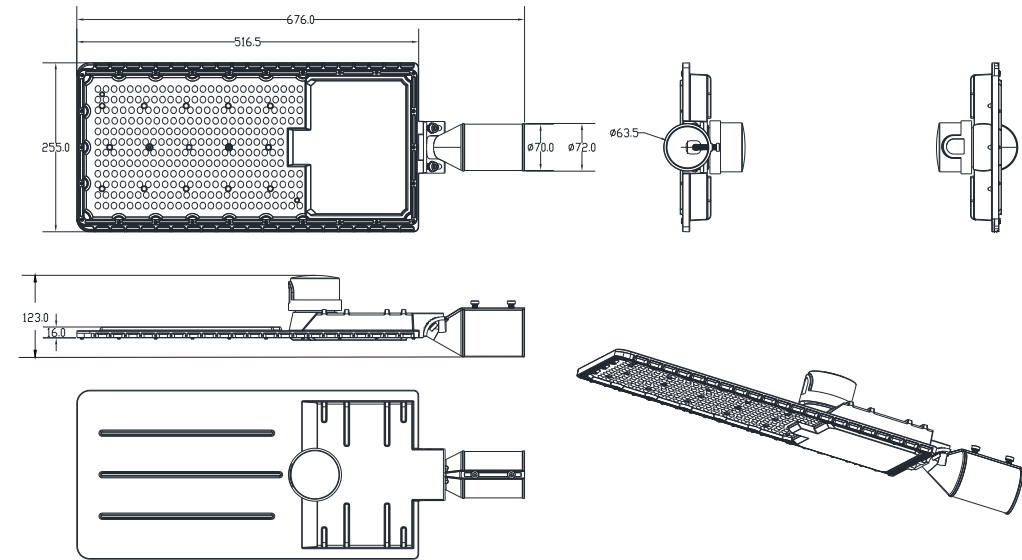

### 最大光强处圆锥面光强分布曲线

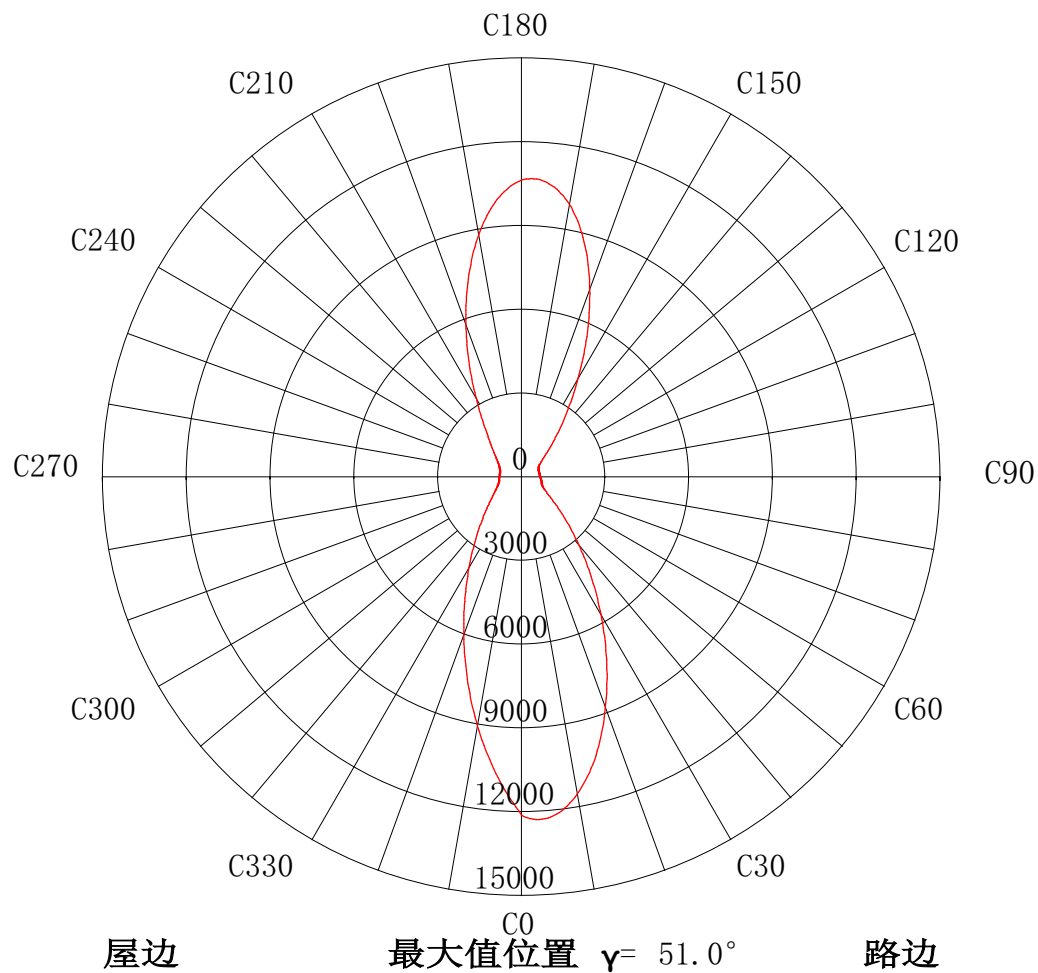

### 子午面配光曲线

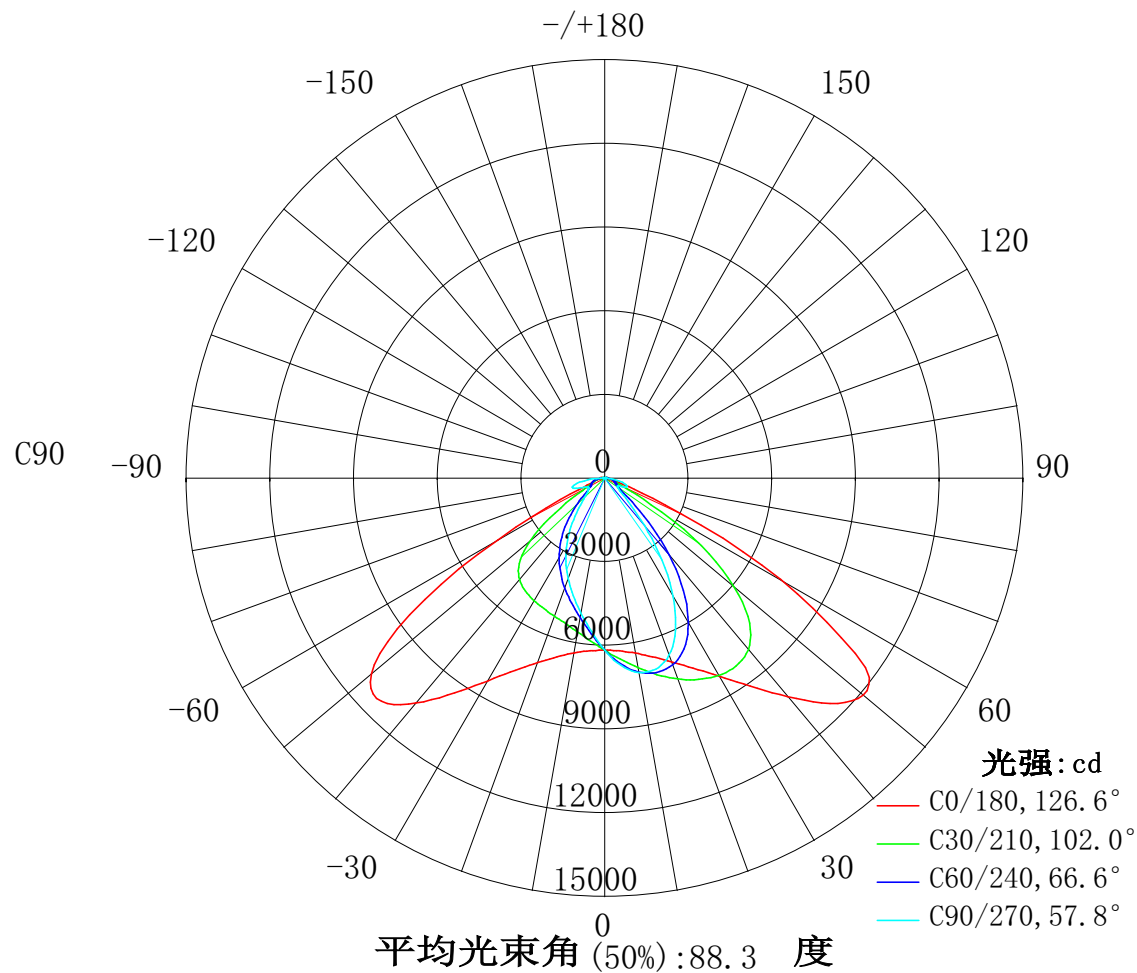

Product Series	AX-LD-FD2-200W
Size of Carton	680mm*260mm*100mm
Packing quantity	1 pcs/carton
Net weight	2.84kg
Gross weight	3.40kg

## Accessories



Light sensor(Need to buy)

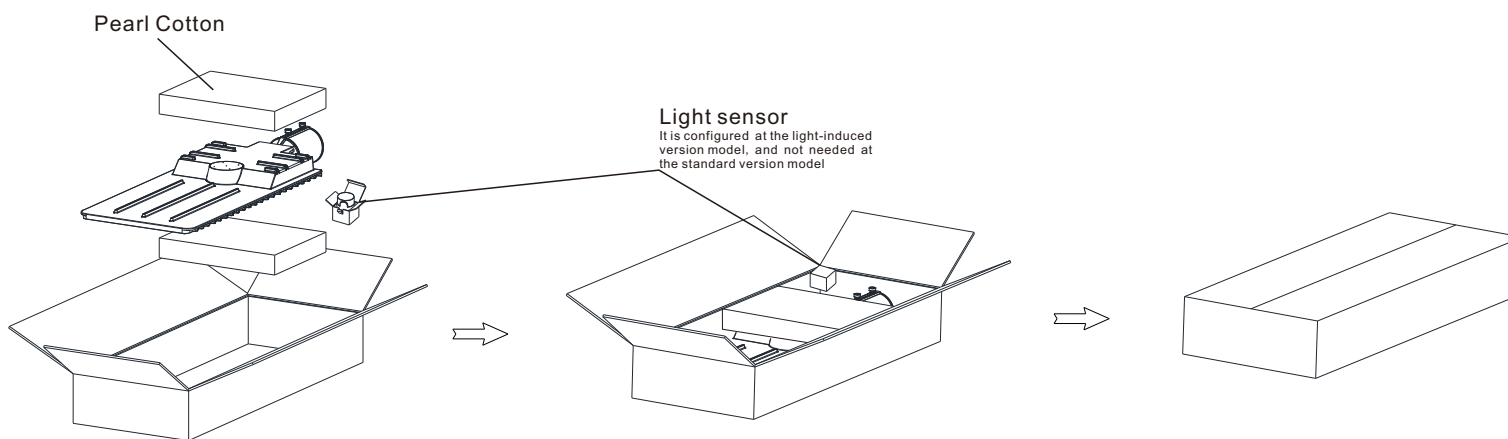

## The experimental temperature

Product Name	position	Temperature	Ambient temperature	Temperature rise
AX-LD-FD2 -200W	LED junction	91.7°C	34.0°C	57.7°C
	PCB	78.7°C	34.0°C	44.7°C
	housing	76.6°C	34.0°C	42.6°C
	Driver	73.5°C	34.0°C	39.5°C

LED junction

PCB

Housing

Driver

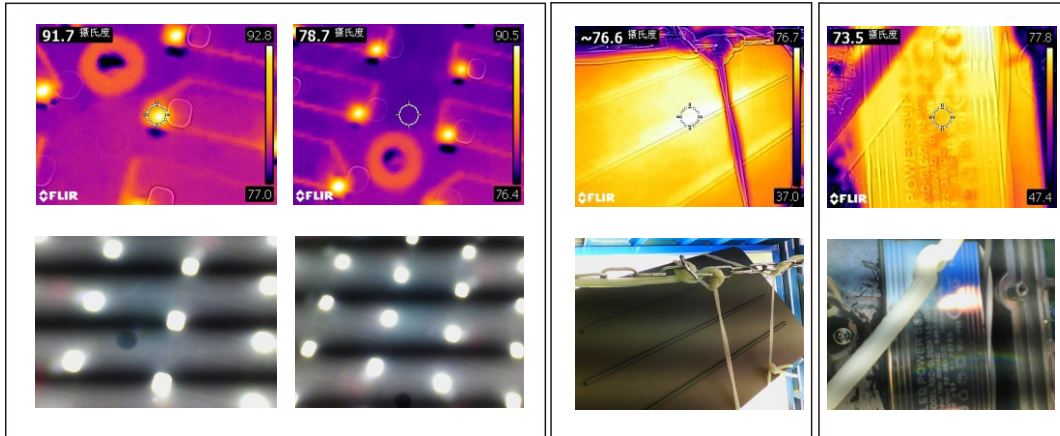

## OFF

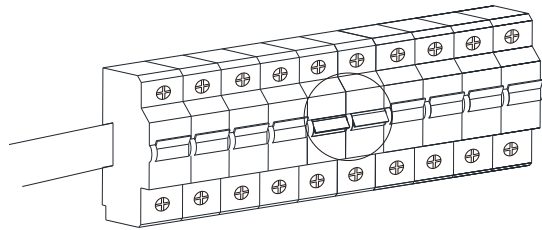
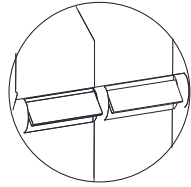

Turn off the power before installing the lamp

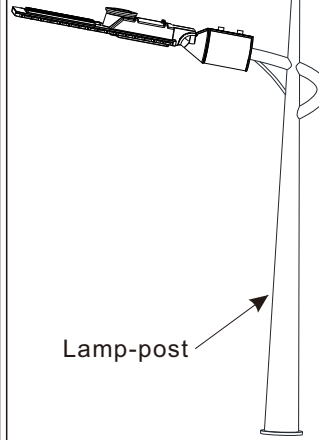

Set screws

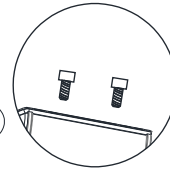

Lamp-post

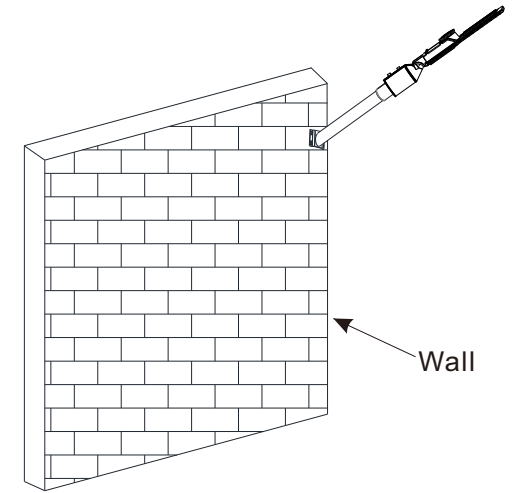

Wall

### Adjust to the right Angle

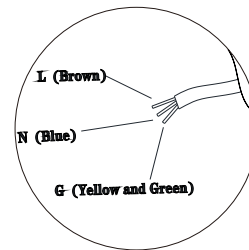
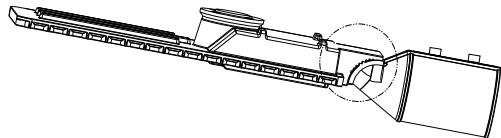
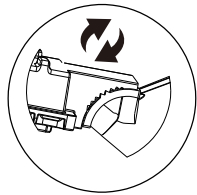

L (Brown)

N (Blue)

G (Yellow and Green)

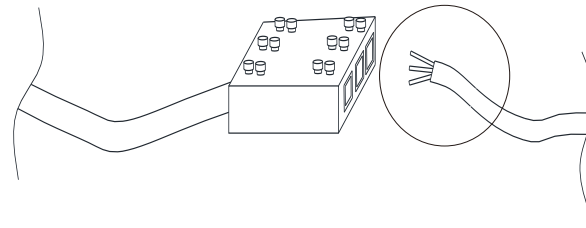

## ON

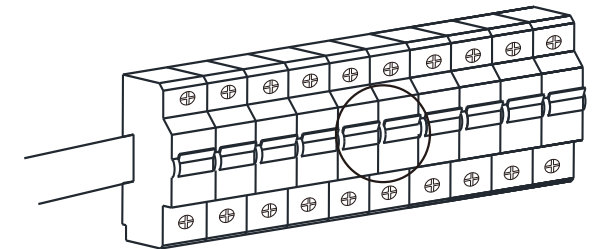
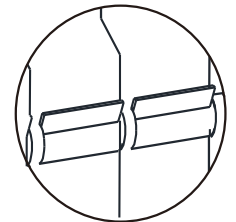

Please turn on the power after installation



让身边的人, 因我而幸福

Let the people around me, because of me and happiness  
Let the people around me, because of me and happiness

Zhongshan Aixuan Lighting Technology, Co. Ltd