



ZHENGZHOU FIVE STAR LIGHTING CO., LTD.

www.fsdlighting.com

<http://fivestarlight.en.alibaba.com>

Tel: +86-371-63223999 Mob: +86-13598018017 E-mail: admin@fsdlighting.com

NO.66 JINGSAN ROAD, JINSHUI DISTRICT, ZHENGZHOU, CHINA



Zhengzhou Five Star Lighting Co., Ltd.

Our vision:
Become one of the mainstream lighting suppliers in the world



Our vision:
Become one of the mainstream lighting suppliers in the world

Our mission:
Bringing Color to the World Lighting

Wherever you go...

Street and road luminaires of the chinese manufacturer FSD Lighting represent modern solutions, energy efficiency, durability and safety. They provide both effective and eye catching lighting.

Our luminaires are characterised by:

- Excellent quality at a competitive price
- Design developed by our own R&D department
- Efficiency up to 170 lm/W
- Power range from 25w to 1800 W
- Luminous flux range from 1,500 to 25,200 lm
- Very high IP66 ingress protection
- Wide range of light distribution

COMPANY PROFILE

Zhengzhou five star Lighting Co., Ltd. is a professional and comprehensive LED lighting solution provider in China, engaged in the design, R&D, manufacturing, sales and service of outdoor LED lighting products, covering industrial lighting, commercial lighting, intelligent lighting and other fields.

The department of international commerce is located in Zhengzhou, has 500 square meters and 30 employees. the manufacturing department was established in 2012. The factory is located in Shenzhen and Zhongshan and other places, with about 5500 square meters and 150 employees.

Our products have passed CCC, FCC, UL, SAA, CE, RoHS, and many other international quality system certifications. At present, our products have been exported to more than 70 countries in North America, South America, Europe, the Middle East, Africa, Southeast Asia, etc., and have been unanimously recognized by customers.

In addition, we are also committed to integrating China's top qualified manufacturers to provide various customized lighting products to meet the different needs of customers. We adhere to the principle of mutual benefit and help our customers gain market leadership with professional services, high-quality products and competitive prices.

Whether you need any of our products or are looking for help with engineered lighting, please feel free to contact us. Looking forward to cooperating with you and presenting satisfactory products for you!



“ LED Street Light ”

Our vision:
Become one of the mainstream lighting suppliers in the world



FSD-G7

High efficiency 130lm/w, 150lm/w, 170lm/w available

Material: ADC12/Alu

Led light source: Philips 3030

Led driver: Meanwell/sosen

Life span: 50000h

Warranty: 5years



Model type	Beam angle	Colour temperature	Efficiency
FSD-G7	60/90/120	2800K-6000K	120-170lm/w





FSD-G7

0/1-10v dimming, microwave sensor, daylight sensor available

Material: ADC12/Alu

Led light source: Philips 3030

Led driver: Meanwell/sosen

Life span: 50000h

Warranty: 5years

Color of product



Model type	Beam angle	Efficiency	Colour temperature
FSD-G7	60//90/120°	120-170lm/w	2800-6000k



FSD-G6

Best waterproof Ip66 automatic

Material: ADC12/Alu

Led light source: Philips 3030

Led driver: Meanwell/sosen

Life span: 20000h

Warranty: 5years

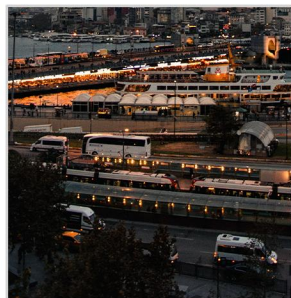

Model type	Beam angle	Efficiency	Colour temperature
FSD-G6	60//90/120°	120-170lm/w	2800-6000k

FSD-G6

Hihighway lighting system dimmable

Material: ADC12/Alu

Led light source: Philips 3030

Led driver: Meanwell/sosen

Life span: 20000h

Warranty: 5years



Model type	Beam angle	Efficiency	Colour temperature
FSD-G6	60//90/120°	120-170lm/w	2800-6000k

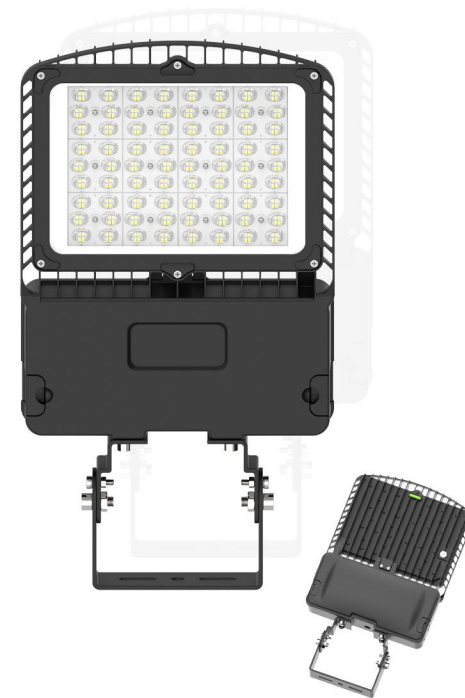

FSD-G6

Patent Professional Black With Light Sensor

Material: ADC12/Alu

Led light source: Philips 3030

Led driver: Meanwell/sosen

Life span: 20000h

Warranty: 5years



Model type	Beam angle	Efficiency	Colour temperature
------------	------------	------------	--------------------

FSD-G6	60//90/120°	120-170lm/w	2800-6000k
--------	-------------	-------------	------------

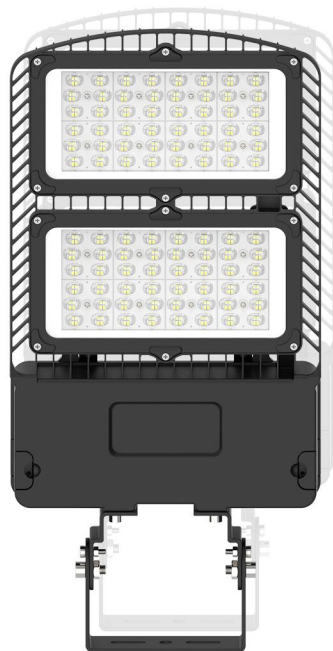

FSD-G6

Smart Led Street Light Ip66

Material: ADC12/Alu

Led light source: Philips 3030

Led driver: Meanwell/sosen

Life span: 20000h

Warranty: 5years



Model type	Beam angle	Efficiency	Colour temperature
------------	------------	------------	--------------------

FSD-G6	60//90/120°	120-170lm/w	2800-6000k
--------	-------------	-------------	------------

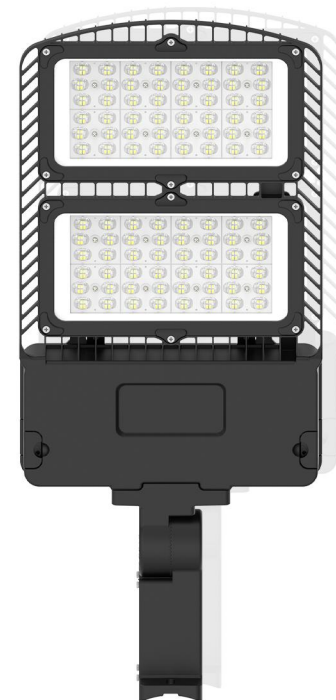



“ Solar Light ”

Our vision:

Become one of the mainstream lighting suppliers in the world



FSD-YXR

Remote control distance up to 15 meters

Working Time : 12-15 hours (5-7 rainy days)

Battery: Built-in large capacity LifePO4 battery

Material: Imported high-efficiency monocrystalline silicon

Control Mode: Time control + Microwave induction or Infrared induction

Warranty: 3years

Color of product



Model type	LED Type	Colour temperature	Efficiency
FSD-YXR	5050	2700K-6500K	120-180lm/w





FSD-HT

Intelligent charge and discharge controller

CRI (Ra>): 70

Lifespan: 50000hours

LED Light Source: epistar

Mounting height(m): 4-5

IP Rating: IP65



Model type	Input Voltage	Working Time	Lamp Body Material
FSD-HT	DC12V	20000hours	Aluminum Alloy



FSD-HT2

Remote control all in one solar automatic light

CRI (Ra>): 70

Lifespan : 50000hours

IP Rating: IP65

Remote Control:2-6 meters

Lithium Battery: 3.2V/5AH,3.2V/10AH,3.2V/15AH



Model type	Input Voltage	Working Time	Lamp Body Material
FSD-HT2	DC12V	10-12hours	ABS

(anti-corrosion, anti ultraviolet)



FSD-SD

Wind and photovoltaic hybrid power

Material: Alu + glass

Led light source: Philips 3030

Led driver: Meanwell/sosen

Life span: 60000h

Warranty: 5years



Model type	Beam angle	Efficiency	Colour temperature
FSD-SD	60/90/120°	120-170lm/w	2800K-6000K



FSD-SD

Hot dip galvanizing + electrostatic coating pole

Material: Alu + glass

Led light source: Philips 3030

Led driver: Meanwell/sosen

Life span: 60000h

Warranty: 5years



Model type	Beam angle	Efficiency	Colour temperature
FSD-SD	60/90/120°	120-170lm/w	2800K-6000K



FSD-HT3

Intelligent remote control, light operated

Solar Panel: 10V/50w

SMD Chip: San'an 5730

Battery: 6.4v/25AH/10 batteries

Charge and discharge times: ≥1200times

Service life: 2 years for battery,3-5years for solar panel

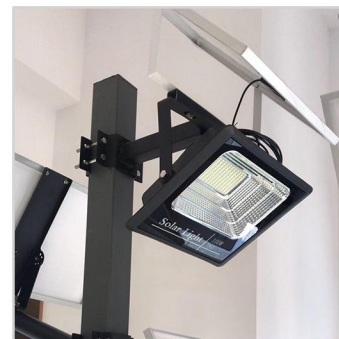

Model type	Packaging	Charging	IP Rank
FSD-HT3	19.5kg/CTN	4-6hours	IP65-IP67

(anti-corrosion, anti ultraviolet)

“ LED Flood Light ”



Our vision:
Become one of the mainstream lighting suppliers in the world



FSD-GLT

0/1-10V dimming,time control

IP Rank: IP66

Warranty: 5years

Lens: Glare free lens

Color: Matte black,Silver grey,other colors customizable

LED Driver: Able to match Meanwell and other mainstream drivers in the market



Model type	LED Type	Efficiency	Colour temperature
FSD-GLT	Lumileds 3030/5050	120-150lm/w	2800-6500k



FSD-GLT

Good heat dissipation, long lifespan

IP Rank: IP66

Warranty: 5years

Power: 10-350W (Customized)

Beam angle: 30°/60°/90°/120°/T2M/T3M

Cover: Good heat dissipation, long lifespan,
excellent corrosion-proof



Model type	LED Type	Efficiency	Colour temperature
FSD-GLT	Lumileds 3030	120lm/w	3000-6500k





FSD-GLT

Patent private mould,integrated die-casting AL

CRI: Ra>80

IP Rank: IP66

Warranty: 5years

Lens angle: 7°/15°/30°/60°/90°/120°/T2M/T3M/T4M

Cover: Good heat dissipation, long lifespan,excellent corrosion-proof



Model type	LED Type	Efficiency	Colour temperature
FSD-GLT	3030/S050	100-150lm/w	3000-6000k



FSD-GLT

0/1-10V dimming, microwave sensor, daylight sensor available

PF: >0.9

THD: ≤15%

Warranty: 5years

Luminous Flux: 6750LM±10%, 13500LM±10%

Lens Angle: 15°/30°/60°/90°/120°/T2M/T3M/30°*90°/50°*120°for option

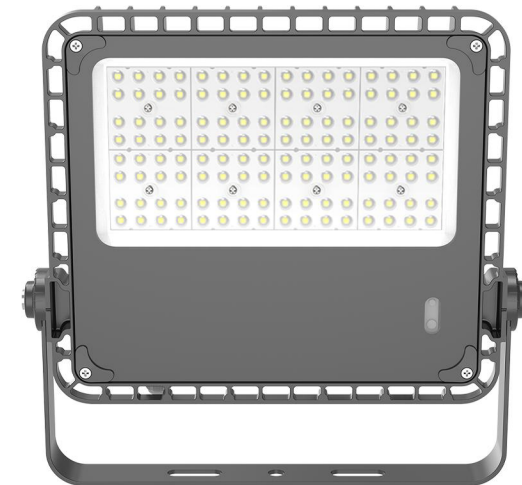

Model type	LED Type	Efficiency	Colour temperature
FSD-GLT	2835	140lm/w	3000-6000k

“ High bay Light ”

Our vision:

Become one of the mainstream lighting suppliers in the world

AUSK series
Green Time

AUSK series
Shangri-La

AUSK series
Blue Snow White

AUSK series
Purple Dream

AUSK series
Pink Dream





FSD-S1

Glare-free design, UGR<25

Material: Aluminum

Led Light Source: PCT 3030

Led Driver: Meanwell/soseen

Life Span: 50000h

Warranty: 5years

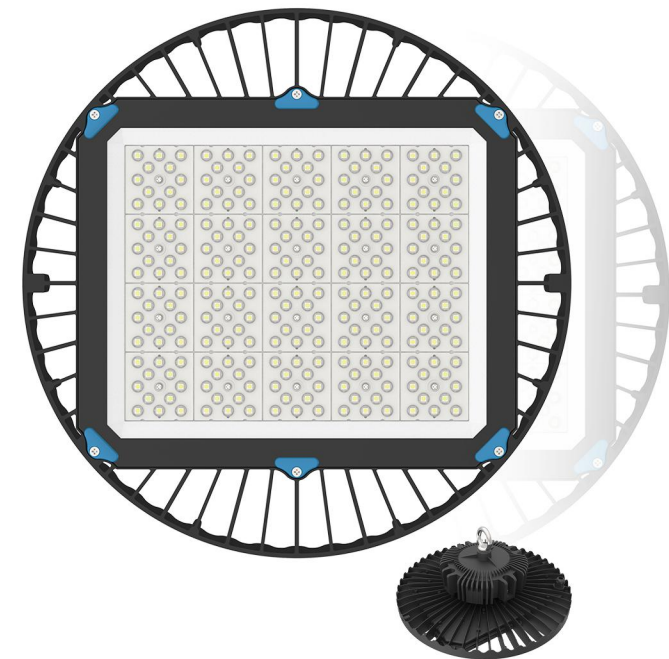

Model type	Beam angle	Colour temperature	Efficiency
FSD-S1	60/90	2800K-6000K	120-150lm/w



FSD-GLT

1-10V dimmable, microwave sensor available

IP Rank: IP65

Power(w):100-240

Voltage: AC100V-240V 50/60HZ

Warranty: 5years

Luminous Flux: 12000LM \pm 5% , 18000LM \pm 5% ,
4000LM \pm 5% , 28800LM \pm 5%

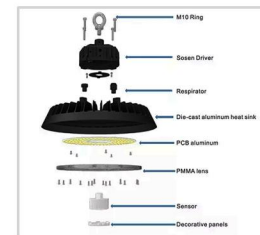

Model type	LED Type	Efficiency	Colour temperature
FSD-GLT	Lumileds 3030/5050	120-130lm/w	2800-6500k

YXR-UFOB

ZigBee pwm 0/1~10v micro-wave available

Surge Protection: 4KV

Led Light Source: San'an 2835

Led Driver: Able to match Meanwell and other mainstream drivers in the market

Life Span: 50000h

Warranty: 5years



Model type	Beam angle	Colour temperature	Thermal Conductivity
YXR-UFOB	60°/90°/120°	2800K-6500K	96 W/m-K





YXR-UFOF

ZigBee pwm 0/1~10v micro-wave available

Surge Protection: 6KV

Led light source: LUMILEDS 3030

Led driver: Able to match Meanwell and other mainstream drivers in the market

Life span: 50000h

Warranty: 5years

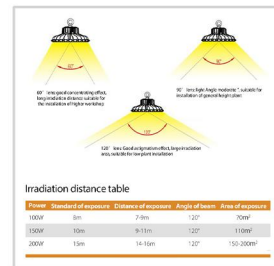

Model type	Beam angle	Colour temperature	Input voltage
YXR-UFOF	60°/90°/130°	3000K-6500K	AC100-305V 50-60Hz



FSD-QC

Meanwell LED driver AC 100-305v

Material: Aluminum+PC

Led Type: LUMILEDS 5050

Led driver: Meanwell

Life span: 50000h

Warranty: 5years

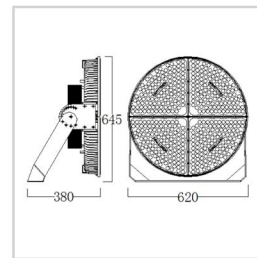

Model type	Beam angle	Colour temperature	Efficiency
FSD-QC	10/25/45/60°	3500K-6500K	120-170lm/w



YXR-A

IP54 with PC cover, free of dust and small splash water

Surge Protection: 6KV

Led light source: San'an/Lumileds 3030

Led driver: Able to match Meanwell and other mainstream drivers in the market

Life span: 50000h

Warranty: 5years



Model type	Beam angle	Colour temperature	Efficiency
YXR-A	45°/60°/90°/120°	2800K-6500K	120lm/w

“ Solar Garden Light”



Our vision:
Become one of the mainstream lighting suppliers in the world



FSD-HY

Automatically and brightness sensing

Material: ABS + PC

Solar Panel: Polycrystalline silicon

Light Source: SMD2835 LED

Working Temperature(°C): -20 - 60

Working Time: 6-12hours



Model type	Life span	Colour temperature	Warranty
FSD-HY	50000h	2500k-7000k	1years

FSD-CP

Like flower basket in the garden

Material: ABS + PC

Solar Panel: Monocrystalline silicon plate

Light Source: 50LED

Working Temperature(°C): -20 - 60

Working Time: 6-12H



Model type	Product size	G.W	Function
FSD-CP	580*540*375mm	0.5kg	Intelligent light control



FSD-TY

Bright and warm the pathway garden night

Material: ABS + PC

Solar Panel: Monocrystalline silicon plate

Light Source: 16LED

Working Temperature(°C): -20 - 60

Working Time: 6-12H



Model type	Product size	G.W	Function
FSD-TY	130*650mm	0.47kg	Intelligent light control





FSD-QY

New style and new design for night lighting

Material: ABS + PC

Solar Panel: Monocrystalline silicon plate

Light Source: 16LED

Working Temperature(°C): -20 - 60

Working Time: 6-12H



Model type	Product size	G.W	Function
FSD-QY	135*780mm	1.1kg	Intelligent light control



FSD-SD

Mutil-function and single-end

Material: ABS + PC

Solar Panel: Monocrystalline silicon plate

Light Source: 4LED

Working Temperature(°C): -20 - 60

Working Time: 6-12H



CE FC RoHS

Model type	Product size	G.W	Function
FSD-SD	270*80*260mm	0.34kg	Intelligent light control

FSD-SD

Mutil-function and double-end

Material: ABS + PC

Solar Panel: Monocrystalline silicon plate

Light Source: 36LED

Working Temperature(°C): -20 - 60

Working Time: 6-12H



Model type	Product size	G.W	Function
FSD-SD	620*440*380mm	1.17kg	Intelligent light control



FSD-CP

Halo new lawn lights

Material: ABS + PC

Solar Panel: A-Si(Amorphous Silicon)

Light Source: LED

Working Temperature(°C): -20 - 60

Working Time: 6-12H



Model type	G.W	Carton	Light color
FSD-CP	2.2kg	96pcs	White/warm light

FSD-CP

Retro style and black design

Material: ABS + PC

Solar Panel: A-Si(Amorphous Silicon)

Light Source: LED

Working Temperature(°C): -20 - 60

Working Time: 6-12H

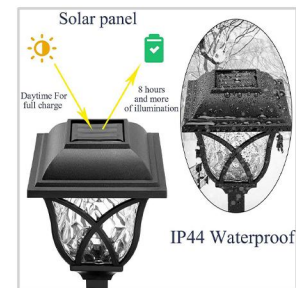

Model type	G.W	Carton	Switch
FSD-CP	1.1kg	6pcs	Green plug switch



FSD-BD

Long bright and large angle of light

Material: ABS + PC

Solar Panel: Monocrystalline silicon plate

Light Source: 48LED

Working Temperature(°C): -20 - 60

Working Time: 6-12H



Model type	G.W	Product size	Function
FSD-BD	0.8kg	210*190*175mm	Intelligent light contro

FSD-SD

High power lamp bead

Material: ABS + Alu

Solar Panel: A-Si(Amorphous Silicon)

Light Source: LED

Working Temperature(°C): -20 - 60

Working Time: 6-12H



Model type	G.W	Product size	Function
FSD-SD	0.9kg	73*315mm	Intelligent light control

“ Solar Wall Light ”



FSD-BD

Multifunctional and fashionable for your life

Material: ABS + PC

Solar Panel: Monocrystalline silicon plate

Light Source: 36LED

Working Temperature(°C): -20 - 60

Working Time: 6-12H

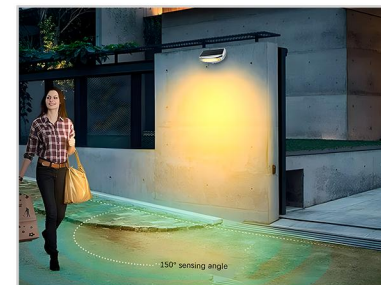

Model type	Product size	G.W	Function
FSD-BD	155*110*60mm	0.38kg	Intelligent light control

FSD-BD

Square window sconces in the wall

Material: ABS + PC

Solar Panel: Monocrystalline silicon plate

Light Source: 2LED

Working Temperature(°C): -20 - 60

Working Time: 6-12H

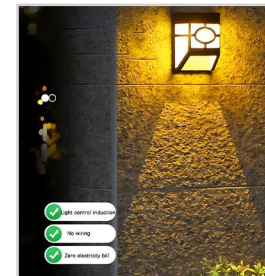

Model type	Product size	G.W	Function
FSD-BD	89*52*114mm	0.38kg	Intelligent light control



FSD-BD

Facing the smile in front of human

Material: ABS + PC

Solar Panel: Monocrystalline silicon plate

Light Source: 3LED

Working Temperature(°C): -20 - 60

Working Time: 6-12H



Model type	Product size	G.W	Function
FSD-BD	105*40*100mm	0.08kg	Intelligent light control

FSD-SD

Shark head appearance modeling

Material: ABS + Alu

Solar Panel: A-Si(Amorphous Silicon)

Light Source: LED

Working Temperature(°C): -20 - 60

Working Time: 6-12H

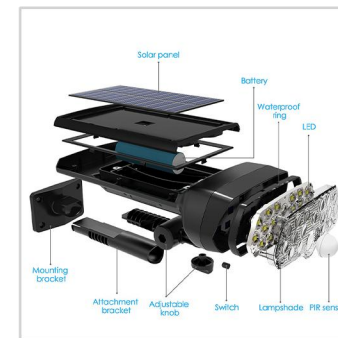

Model type	G.W	Product size	Function
FSD-SD	0.4kg	206*113*92mm	Intelligent light control



“ Housing Assembly Kit ”

Our vision:
Become one of the mainstream lighting suppliers in the world



FSD-LD-K

Thickened heat dissipation design

Material: ADC12/Alu

Led light source: Philips 3030

PCB model: 8C18B

Weight of sink heat(kg): 2.1

Warranty: 1years

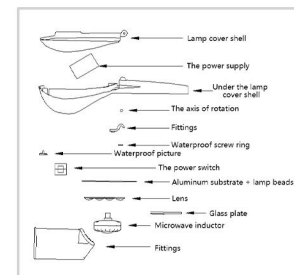

Model type	Power	Beam angle	Packing size(mm)
FSD-LD-K	40/60/80/100w	60/90/120	417*264*155



FSD-LD-K

Thickened heat dissipation design

Material: ADC12/Alu

Led light source: Philips 3030

PCB model: 8C18B

Weight of sink heat(kg): 1.6

Warranty: 1years

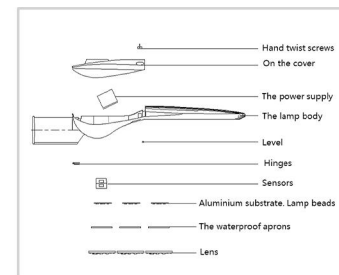

Model type	Power	Beam angle	Packing size(mm)
FSD-LD-K	40/60/80/100w	60/90/120	420*260*150



FSD-TC-K

Thickened heat dissipation design

Material: ADC12/Alu

Led light source: Philips 3030

PCB model: 6C/8CC

Beam angle: 15/30/60/90

Warranty: 1years



Model type	Power	Heat sink weight	Heat sink size
FSD-TC-K	100/150/200/300w	3.35kg	228*95*1.6mm



FSD-KD-K

Thickened heat dissipation design

Material: ADC12/Alu

Led light source: Philips 3030

PCB model: 7C20B

Beam angle: 60/90/120

Warranty: 1years



Model type	Power	Heat sink weight	Heat sink size
FSD-KD-K	100/150/200/300w	0.61kg	240*49mm



FSD-QC-K

Thickened heat dissipation design

Material: ADC12/Alu

Led light source: Philips 3030

PCB model: 7C45B*1

Beam angle: 15/30/60/90

Warranty: 1years

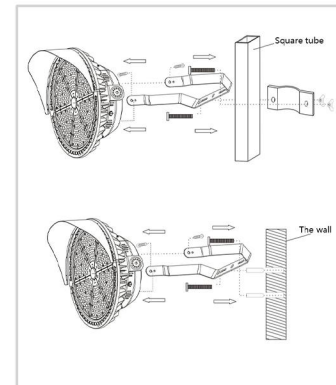

Model type	Power	Heat sink weight	Heat sink size
FSD-QC-K	200/600/800w	1.6kg	Φ400*85mm



FSD-JR

Super heat dissipation performance

Material: ADC12/Alu

Led light source: 3535/5050

PCB model: 14C8B,2C56B

Weight of sink heat(kg): 5

Warranty: 1year

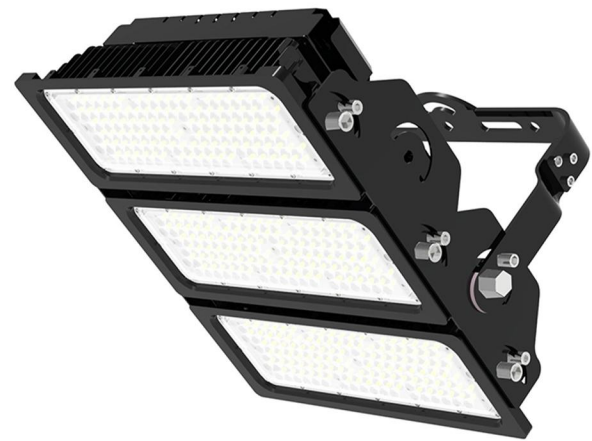











Model type	IP Rank	Beam angle	Heat sink dimensions
FSD-JR	IP66	15/30°	491*382*143mm



FSD-JR

Super heat dissipation performance

Led light source: 3535/5050

PCB model: 13B6C,14B7C

Weight of sink heat(kg): 1.4

Aluminium substrate specifications(mm): 76*150*1.6

Warranty: 1year



Model type	IP Rank	Power	Heat sink dimensions
FSD-JR	IP66	60-120w	336*216*182mm

“ Camping Light ”



Our vision:

Become one of the mainstream lighting suppliers in the world



FSD-YH

Charging portable small power generation system

IP Rank: IP45

Warranty: 1 years

Voltage(v): 7.4

Rated power rating(w): 12

Overall dimensions(mm):11.2 x 18 x 7.9



Model type	Life span	Type of switch	Continuous lighting time
FSD-YH	5000h	Induction type	6-12 h



FSD-YY

Strong adhesion, waterproof and dust-proof

IP Rank: IP45

Warranty: 1 years

Voltage(v): 6

Rated power rating(w): 5

Overall dimensions(mm):φ75*160



Model type	Life span	Type of switch	Continuous lighting time
FSD-YY	10000h	Induction type	12-16 hours



VNS-1905

Remote control button, intelligent light control

Working voltage(v): 3.7

Working current: 1.2A

Lithium battery capacity: 3.7V2200mAx 2pcs

Solar panel: 6V5W(monocrystalline silicon solar panel)

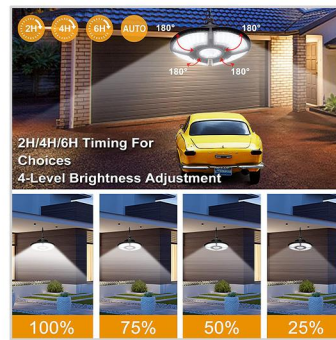

Model type LED Charging time Output power

VNS-1905 136pcs 8 hours 7W



“ Holiday Light ”

Our vision:

Become one of the mainstream lighting suppliers in the world





LH

Solar power, intelligent light control

Working voltage(v): 6

Solar Panel: 600mA

Size(cm): 27.2*13.2*7

Working current: 6mA

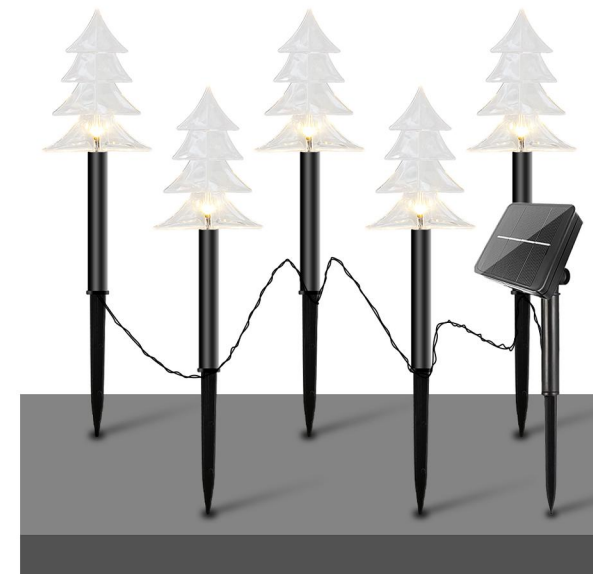

      **CE FC RoHS**

Model type	NW	Material	IP Rating
LH	0.306kg	PC+LED+PVC	IP44



FSD-LH

LED rechargeable smoke lamp

Power Supplier: DC 5V USB

Leds Qty: 120L *4,(Can be customized)

Fucntion: 8fucntions

Remote: 13 Keys

Warranty: 5years

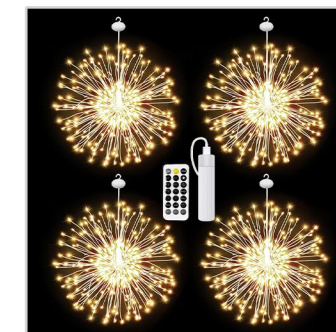

Model type	Length	IP Rating	Flux lumineux
FSD-LH	2*0.15m	IP44	75lm

FSD-HY

Petal-shaped flame effect

Material: ABS

Solar Panel: Polysilicon solar panels

Light Source: LED

Working Temperature(°C): -20 - 60

Working Time: 6-12H



Model type	G.W	Product size	Function
FSD-HY	0.2kg	98*95*246mm	Intelligent light control

FSD-YQ

New shape of round torch

Material: ABS

Solar Panel: Monocrystalline silicon plate

Light Source: LED

Working Temperature(°C): -20 - 60

Working Time: 6-12H



Model type	G.W	Product size	Function
FSD-YQ	0.48kg	160*125mm	Intelligent light control

A close-up photograph of several small green seedlings growing in a dark brown, peat-based seedling tray. The seedlings are in various stages of growth, with some showing two leaves and others just emerging. The background is dark and out of focus, with a thin green horizontal line near the top.

“ Plant Light ”

Our vision:

Become one of the mainstream lighting suppliers in the world

FLG-650

Better canopy light penetration with diffused light

Dimming: 0-100%

PPFD μ mol/(m²/s): 1287

Footprint: 4'x4'/5'x5'ft/6*6'FT

LED Light Source: Epistar 3030+ 660nm

Led driver: 1pc Inventronics driver Meanwell with knob dimmer

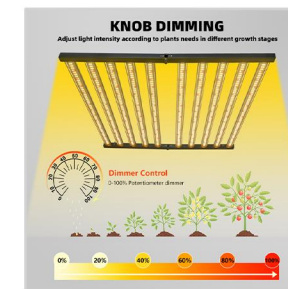







 CE FC RoHS

Model type	Efficacy	Lamp Luminous Flux	Colour temperature
FLG-650	1500	220lm	3000K+4000K



Inspection of incoming materials



Production and assembly



Aging test



Integrating sphere test



IES Light distribution test



High and low pressure test



Water proof test



Product packaging



Shipment

Process of production...

Inspection of incoming materials



Production and assembly



Aging test



Integrating sphere test



IES Light distribution test



High and low pressure test



Water proof test



Product packaging



Shipment



« Die casting workshop

Die casting workshop

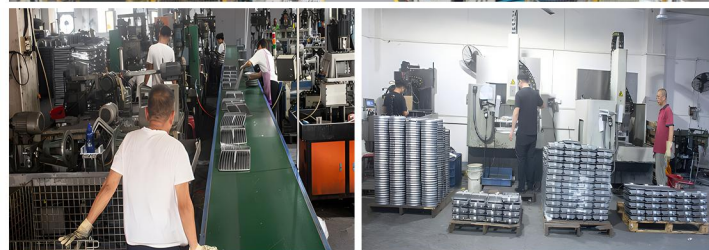

« Machine working shop

Machine working shop



« Powder spraying workshop

Powder spraying workshop



« Assembly shop

Assembly shop

Solar Panel



LED Lamp



Lighting Pole

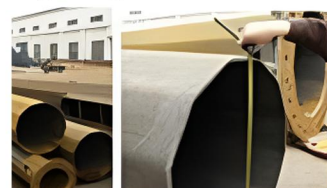

Controller



Product Certification Certificate...

- Our products have passed CCC, FCC, UL, SAA, CE, RoHS, and many other international quality system certifications.
- At present, our products have been exported to more than 70 countries in North America, South America, Europe, the Middle East, Africa, Southeast Asia, etc., and have been unanimously recognized by customers.

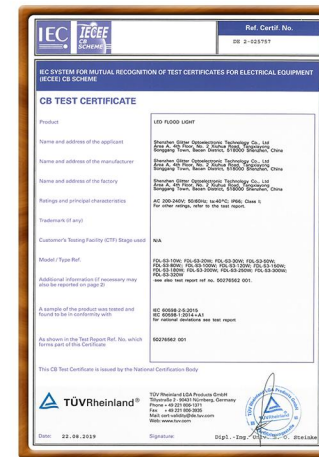
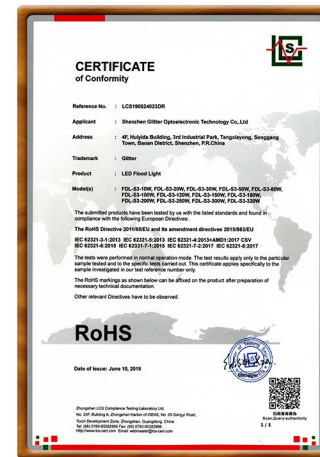
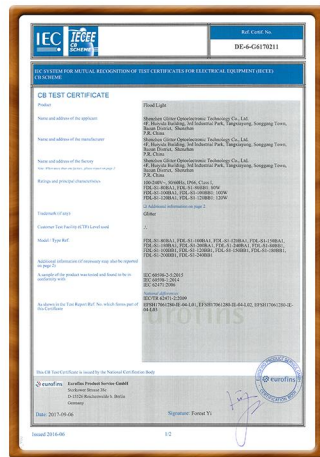

Case scenarios of different categories...

German Hardware Processing Factory (UFOH Mining Lamp)

Los Angeles Industrial Park (WK Wall Lamp)

Suzhou Pharmaceutical Cold Storage (UFOH mining lamp)

Spanish Football Stadium (FLH pitch lights)

Lithuania Airport (FLG Stadium lights)

Dongguan Shatin Logistics Park (UFOH Mining Lamps)

Swedish racecourse (UFOH mining lamp with lampshade)

German Football Stadium (FLL pitch lights)

Thai Road (SLB street light)

Xi 'an Workshop (UFOH Mining lamp)

Xi 'an Campus Stadium (FLP Floodlight)

Dominican Gas Station (CP gas station light)

...

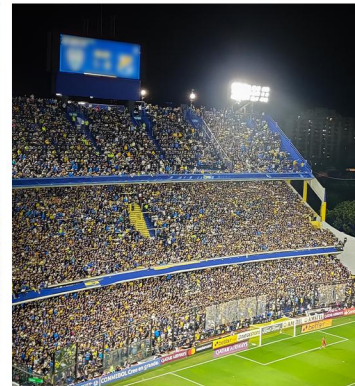
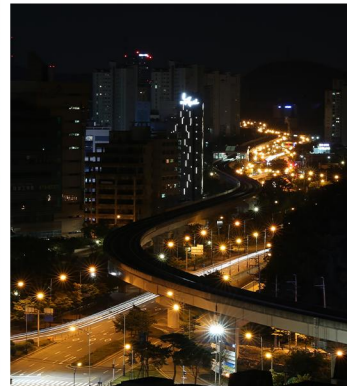
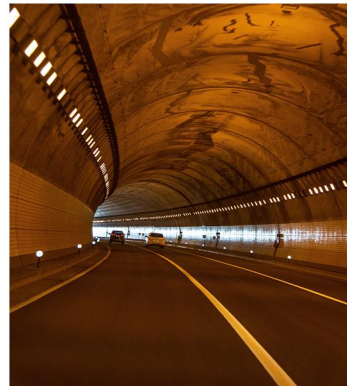
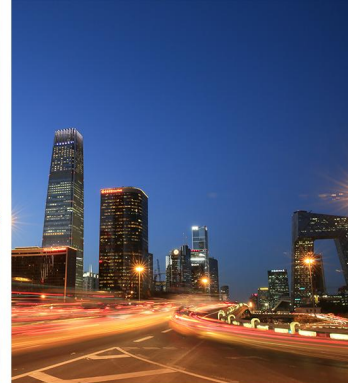
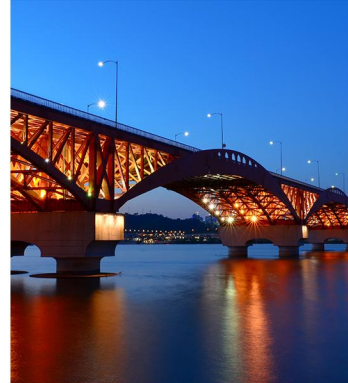

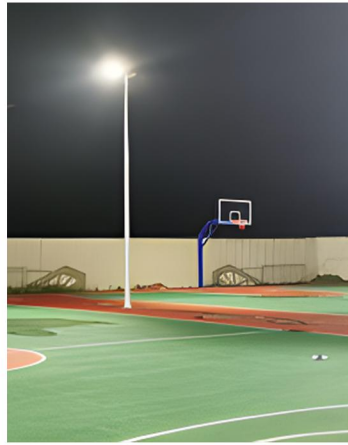



Zhengzhou Five Star Lighting Co., Ltd.



ZHENGZHOU FIVE STAR LIGHTING CO., LTD.

www.fsdlighting.com

<http://fivestarligh.en.alibaba.com>

Tel: +86-371-63223999 Mob: +86-13598018017 E-mail: admin@fsdlighting.com

NO.66 JINGSAN ROAD, JINSHUI DISTRICT, ZHENGZHOU, CHINA

Our vision:

Become one of the mainstream lighting suppliers in the world